

# WHEEL LOADER

# WA900-3

## ADVANCE LOADER

FLYWHEEL HORSEPOWER: 637kW 853 HP @2,000RPM

BUCKET CAPACITIES: 13.0m<sup>3</sup> 17.0cu.yd

OPERATING WEIGHT: 101,550 kg 223,920 lb



Model shown may include optional equipment.

- The powerful Komatsu SA12V140 engine provides fuel-efficient operation
- Roomy, quiet cab with high-capacity air conditioner substantially reduces operator fatigue
- Large bucket capacity and ample dumping clearance/reach make the WA900 an excellent worker's partner with 105 metric tons dump trucks
- Exclusive "Dual Speed Hydraulic System Plus" ensures shorten cycle time
- Kick-down switch on the boom control lever improves pile penetration and scooping operations
- Electrically controlled transmission enables light fingertip control of all direction/gear shift changes
- Tilttable steering wheel and adjustable seat provide operator comfort and efficiency
- Komatsu viscous damping cab mounts reduce vibration and noise
- Adjustment-free service brake accounts for higher performance and reduced downtime
- High-quality components are used for superior reliability and availability

# KOMATSU

# The Answer for Higher Reliability and



# Productivity

## Proven Power

The world/field-proven Komatsu 12-cylinder, direct-injection turbo-charged SA12V140 engine has all the capability needed for today's tough operations.

## Flywheel horsepower

**637kW 853HP @2,000RPM**

## Reliable Power Train

The engine, torque converter and transmission as well as the hydraulic equipment and electrical parts under-go strict quality control checks for enhanced reliability and durability.

## Durable Bucket

Komatsu buckets are manufactured using high-tensile strength steel with replaceable welded wear plates for extended bucket life. Additional strength has been added to the bucket bottom corners, side edges and spill guard ends for increased durability.

## Bucket capacities

**13.0m<sup>3</sup> (17cu.yd)**

## Large Dumping Clearance

The WA900-3 was designed with ample dumping clearance for dump truck matching.

## High Breakout Force

Komatsu wheel loaders have high-tensile steel Z-bar loader linkages for maximum rigidity and maximum breakout force. Sealed loader linkage pins extend greasing intervals.

## Excellent Stability

The WA900-3 has the widest tread in its class 3,350mm (11') and a long 5,450mm (17'11") wheelbase, for maximum machine stability.

## Shortened Cycle Time

● Since the implement requires relatively little hydraulic oil during excavation and scooping, the variable displacement pump's output is reduced. Power freed by reducing the pump load is translated into driving force. As a result, the machine's pushing force increases, which bolsters excavating efficiency.

● During dump approach and other boom-up operations, the variable displacement pump's output is greatly increased. This raises boom speed and reduces cycle times.

● By sensing the engine speed, the system allows the machine to quickly accelerate at low speeds. Also, at low engine speeds the output to the implement pump is reduced, serving as a control to reduce the load on the engine. (Between 800 rpm and 1,100 rpm, the angle of the swash plates in the loader pump and the switch pump is varied depending on engine speed, causing pump output to vary between 50% and 100% of maximum.)

### Excavation and scooping

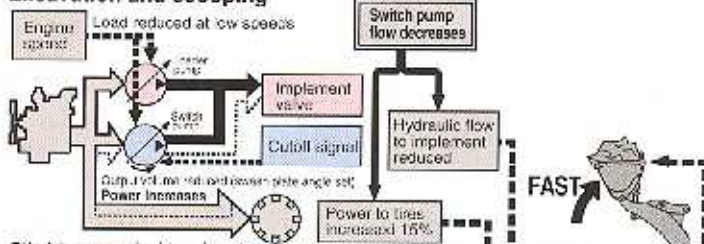

● Switch pump output is reduced.

● Hydraulic load is slight, so major power is transferred to tires.

### Low engine speeds or raising the boom

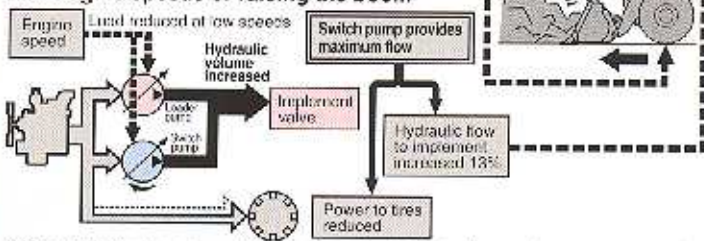

● All hydraulic flow from the switch pump is transferred to the implement. However, at low engine speeds the output volume is controlled to give priority to engine response.

● Power to the tires is reduced only by the amount of the switch pump's driving power.

# Focus on Operator Comfort and



## Easy to Use Joystick Steering (Optional)

A joystick steering system has been incorporated to allow steering and forward/reverse selection to be effected by wrist and finger control without the operator having to move his arm from the rest. The boom lever hold and kick-down switches change to up-shift and down-shift switches respectively.



## Faster Pile-Penetration & Scooping

A kick-down switch down-shifts the transmission from forward 2nd to 1st gear, for increased rim pull and hence improved bucket filling. When the direction control lever is set to reverse, it automatically up-shifts from 1st gear to 2nd, to reduce cycle time.

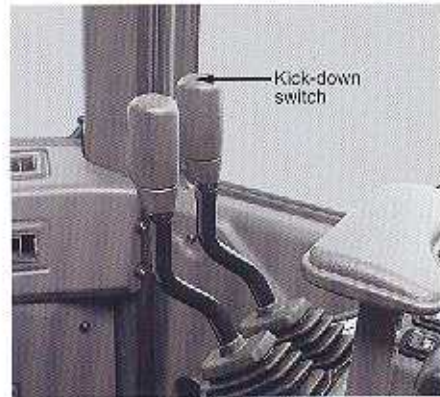

## Ergonomically-Designed Controls

All controls are ergonomically designed to minimize operator fatigue. The steering wheel and instrument panel are similar to those of a car. The bucket and boom controls have PPC valves and short-stroke levers, to reduce operator effort. With the electrically-controlled transmission, direction and gearshift control levers can be finger-operated while holding the steering wheel with the same hand, allowing instant, positive direction and gearshift changes.

## Comfortable Operator's Seat

The operator's seat has a reclining/air suspension design with headrest to support the operator comfortably during long operation. Also, it is easy to adjust seat height with air suspension.

# Easy Maintenance

## Smooth Electronic Automatic Transmission (Optional)

With the electronic automatic transmission, you can always enjoy the optimum speed for the machine travelling conditions. Clutch engagement during gear shifting is so smooth that time lag and shock are small and ride comfort is ensured. When ascending or descending a slope or while operating, the automatic transmission can easily be set to the standard manual transmission by using the manual switch.



## Tiltable Steering Column & One-Glance Monitors

The steering column can be easily tilt-adjusted to the most comfortable position with one lever. Together with the two-spoke design, this guarantees better vision of the monitors.



## Stair Light

The stair light, which illuminates the rear access stairs for about a minute, is operated by pushing a switch inside the cab, regardless of ignition key position.

## Roomy, Quiet Cab With Power Windows

The cab is large, with a comfortably spacious interior and power windows. Also, a wide viewing angle is guaranteed because the cab is pillar-less. By adopting a high-capacity air conditioner, Komatsu ensures operator comfort, no matter the exterior conditions. Other features designed with operators in mind include a lunchbox storage space.



## Low Vibration & Noise

The cab rests on Komatsu viscous damping mounts (rubber and silicon oil) to reduce vibration and noise. All hydraulic equipment is mounted on high-resistance rubber to further reduce vibration and noise.

Viscous damping mounts

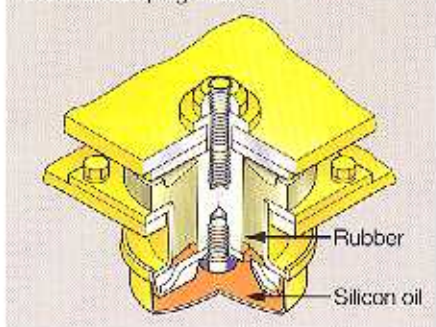

## Auto-Greasing System (optional)

The periodic lubrication points, except for drive shaft, are greased automatically according to a preset amount and interval. Quick-change grease canisters make replacement easy and clean.

## Simple Checks, Easy Maintenance

The main monitor and the maintenance monitor (EDIMOS II) are neatly arranged on the instrument panel for a quick, clear reading of machine functions at all times. The main monitor also has a diagnostic function.



## High-Quality Paint

Most exterior plates are treated with a cationic electro-deposition undercoat and melamine baked final paint for rust resistance and longer service life.

## Maintenance-Free Braking System

Service brakes employ two hydraulically-actuated independent circuits for increased safety and are adjustment-free, fully-sealed, wet disc units, preventing intrusion of dirt and dust. Since the brake system does not use air, it provides many features such as absence of condensation, dependable braking even in cold conditions, no need for drainage, and rust free piping. What's more, charging time after engine starting is drastically shortened and pedal depressing effort is reduced.

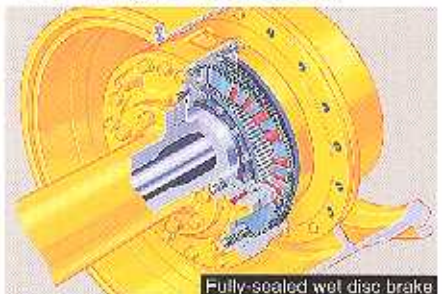

# SPECIFICATIONS



## ENGINE

Model.....	Komatsu SA12V140
Type.....	Water-cooled, 4-cycle
Aspiration.....	Turbocharged
No. of cylinders.....	12
Bore × stroke.....	140mm × 165mm 5.5" × 6.5"
Piston displacement.....	30.5 ltr. 1,861 cu.in
Performance:	
Flywheel horsepower.....	<b>637 kw</b> 853 HP (SAE J1349) <b>637 kw</b> 865 PS (DIN 6270)
Rated RPM.....	2,000 RPM
Fuel system.....	Direct injection
Governor.....	Mechanical, all-speed control
Lubrication system:	
Lubrication method.....	Gear pump, pressurized lubrication
Filter.....	Full-flow type
Air cleaner.....	Dry type with automatic dust ejector and precleaner, cyclopac with vacuator



## TRANSMISSION

Torque converter:	
Type.....	3-element, single-stage, single-phase
Transmission:	
Type.....	Full-powershift, planetary gear type
Travel speed:km/h MPH	
Measured with 45/65-45-58R tires	
	1st      2nd      3rd
Forward	7.0 4.3    12.3 7.6    28.0 17.4
Reverse	7.1 4.4    12.4 7.7    28.3 17.6



## AXLES & FINAL DRIVES

Drive system.....	Four-wheel drive
Front.....	Fixed, full-floating
Rear.....	Center-pin-support, full-floating ± 11° oscillation
Reduction gear.....	Spiral bevel gear
Differential gear.....	Straight bevel gear
Final reduction gear.....	Planetary gear, single reduction, oil bath



## BRAKES

Service brakes.....	4-wheel, systematic brake for front/rear wheel, hydraulically actuated, wet disc
Parking brake.....	Dry-disc type, hydraulic released, spring applied on front axle input shaft
Emergency brake.....	Uses parking brake



## STEERING SYSTEM

Type.....	Articulated type, full-hydraulic power steering
Steering angle.....	40° each direction
Minimum turning radius at the center of outside tire.....	<b>9,200 mm</b> 30' 2"



## HYDRAULIC SYSTEM

Steering system:	
Hydraulic pump.....	Piston pump
Capacity.....	<b>307 ltr./min.</b> 81 U.S. gal/min. at rated RPM
Relief valve setting.....	<b>350 kg/cm<sup>2</sup></b> 4,977 PSI
Hydraulic cylinders:	
Type.....	Double-acting, piston type
No. of cylinders.....	2
Bore × stroke.....	<b>160 mm × 503 mm</b> 6.3" × 19.8"
Loader control:	
Hydraulic pump.....	Piston pump
Capacity.....	<b>405 ltr./min.</b> 107 U.S.gal/min. at rated RPM
Relief valve setting.....	<b>350 kg/cm<sup>2</sup></b> 4,977 PSI
Switch pump.....	Piston pump
Capacity.....	<b>405 ltr./min.</b> 107 U.S.gal/min. at rated RPM
Hydraulic cylinders:	
Type.....	Double-acting, piston type
No. of cylinders-bore × stroke:	
Boom cylinder.....	<b>2- 260 mm × 1,368 mm</b> 10.2" × 53.9"
Bucket cylinder.....	<b>1-300 mm × 906 mm</b> 11.8" × 35.7"
Control valve.....	Spool type
Control positions:	
Boom.....	Raise, hold lower and float
Bucket.....	Tilt-back, hold and dump
Hydraulic cycle time (rated load in bucket)	
Raise.....	11.2sec. Dump..... 2.8sec.
Lower (Empty).....	4.8sec.



## ROPS & CAB

Structure complies with ISO 3471 and SAE J1040c ROPS (Roll-Over Protective Structure) standards, as well as ISO 3449 FOPS (Falling Object Protective Structure) standards. The cab is mounted on viscous mount and well insulated.



## SERVICE REFILL CAPACITIES

Cooling system.....	<b>301 ltr.</b> 79.5 U.S.gal
Fuel tank.....	<b>1,430 ltr.</b> 377.6 U.S.gal
Engine.....	<b>132 ltr.</b> 34.9 U.S.gal
Hydraulic system.....	<b>725 ltr.</b> 191.5 U.S.gal
Axle (each front and rear).....	<b>360 ltr.</b> 95.1 U.S.gal
Torque converter and transmission.....	<b>140 ltr.</b> 37 U.S.gal



## TIRES

Front and rear 45/65-45-58PR(L-5)

## BUCKET SELECTION

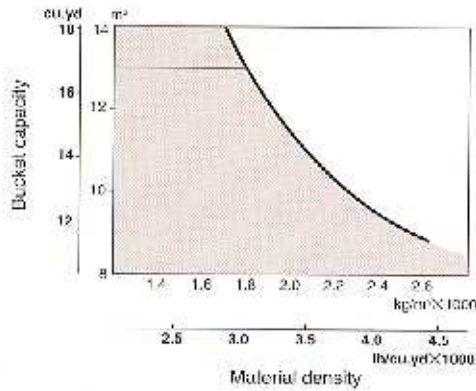

Excavating bucket (spade nose) with tipteeth

Capacity Heaped m³ cu. yd	Struck	Bucket width* mm ft. in	Bucket weight kg lb	Breakout force kg lb
13.0	11.0	4,810	12,320	67,900
17.0	14.4	15'9"	27,160	149,690

\*Excluding tire protectors

	Operating weight kg lb	Static tipping load kg lb	
		Straight	40° full turn
Tires/Buckets			
45/65-45-58PR(L-5)	101,550 223,660	66,140 145,810	58,200 128,310

- All dimensions, weights and performance values based on SAE J732c and J742b standards.
- Static tipping load and operating weight shown include lubricant, coolant, full fuel tank, steel cab, ROPS canopy, air conditioner, tip type teeth and operator. Machine stability and operating weight are affected by counterweight, or ballast, tire size and other attachments. Use either counterweight or ballast, not both. Apply the following weight changes to operating weight and static tipping load.

## WEIGHT CHANGES

	Change in operating weight		Change in tipping load			
			Straight		Full turn	
Remove ROPS canopy	-1,365 kg	-3,055 lb	-1,220 kg	-2,690 lb	-1,180 kg	-2,600 lb
Remove steel cab	-430 kg	-950 lb	-335 kg	-740 lb	-330 kg	-730 lb

## STANDARD EQUIPMENT

**Engine and cooling system:** Starter, Alternator, Preheater, Corrosion resistor

**Electrical components:** Headlights(2), Rear working lights(2), Brake lamps or tail lamps, Turn indicators (front and rear), Electric display/monitoring system/slab light

**Gauges:** Fuel level, Coolant temperature, Torque converter oil temperature, Speedometer, Service meter

**Pilot lamps:** Engine preheating, Working light on, Turn indicator on, Parking brake applied, Transmission cut-off

**Monitor lights:** Engine oil level, Brake oil level, Coolant level

**Caution lamps:** Battery charging, Fuel level, Transmission oil filter clogging, Air cleaner filter clogging

**Caution lamps with alarm:** Engine oil pressure, Coolant level, Coolant temperature, Torque converter oil temperature, Parking and neutral, Brake oil pressure

**Others:** Sight gauges (hydraulic reservoir level, transmission oil level, brake oil level), Dust indicator, Emergency brake, 45/65-45-58PR (L-5) lubeless tires, Bucket positioner, Boom kickout, Air suspension seat

## OPTIONAL EQUIPMENT

Front working lights(2), Side working lights(2), Air conditioner, Heater and defroster, Car radio, Sun visor, Fire extinguisher, Vandalism protection kit, Emergency steering, Yellow rotating lamp, Backup alarm, Underview mirror, Power-train underguard, Ashtray and cigarette lighter, Rear under view mirror, Room mirror, Seat belt, Fenders, Bucket teeth (weld-on/tip type), Bucket corner teeth, Sweeper wing, 11.5m³ (15 cu. yd) spade nose rock bucket for high-lift boom, High-lift boom, Counterweight for high-lift boom, ROPS canopy, Steel cab included front wiper, windshield washer and power window, Fast fill fuel system, Auto-greasing kit, Joystick steering, Automatic transmission, Coal bucket, Auto-greasing system

## Specifications with High-Lift Boom

		Spade Nose with teeth
Bucket capacity	m³	11.5
Rated Load	kg	20,700
Bucket width	mm	5,045 (4,760)
Dumping Clearance (teeth)	mm	5,635(5,255)
Dumping Reach (teeth)	mm	2,000(2,235)
Tire Size	-	45/65-45-58PR (L-5)

( ) without tire guard

## DIMENSIONS

(Unit:mm (In))

45/85-45 tires

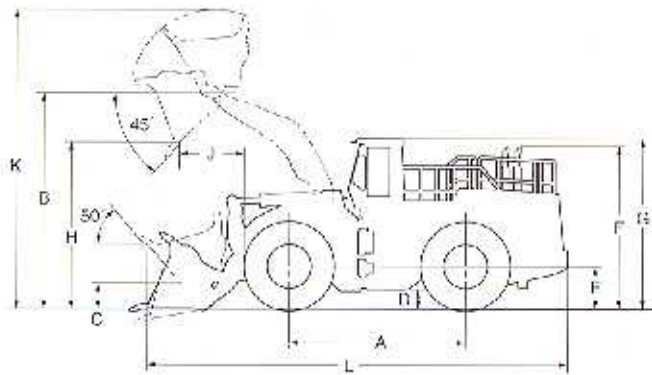

Tread	3,350	11'
Width over tires	4,585	15'1"
A Wheelbase	5,450	17'11"
B Hinge pin height,max. height	6,960	22'10"
C Hinge pin height, carry position	800	2'7"
D Ground clearance	550	1'10"
E Hitch height	1,300	4'3"
F Overall height, top of the stack	5,080	16'8"
G Overall height, ROPS canopy	5,275	17'4"

### Measured with 45/65-45 tires

	Buckets	I
H. Dumping clearance, max. height and 45° dump angle (edge)*		4,640 15'3"
J. Reach at max. height and 45° dump angle (edge)*		2,450 8'
Reach at 2130 mm (7") cut edge clearance and 45° dump angle (edge)		3,650 12'
Reach with arm horizontal and bucket level (edge)		4,640 15'3"
K. Operating height (fully raised)		9,680 31'9"
L. Overall length (with tooth)		14,270 46'10"
Loader clearance circle (bucket at carry, outside corner of bucket)		22,000 72'2"
Digging depth (at teeth)	0"	160 6"
	10"	645 2'1"

\*At the end of teeth

This specification sheet may contain attachments and optional equipment that are not available in your area. Please consult your local Komatsu distributor for those items you may require. Materials and specifications are subject to change without notice.

# KOMATSU